

3

# Oil Engines *for* Crude Oils.

*M. T. H. L.*

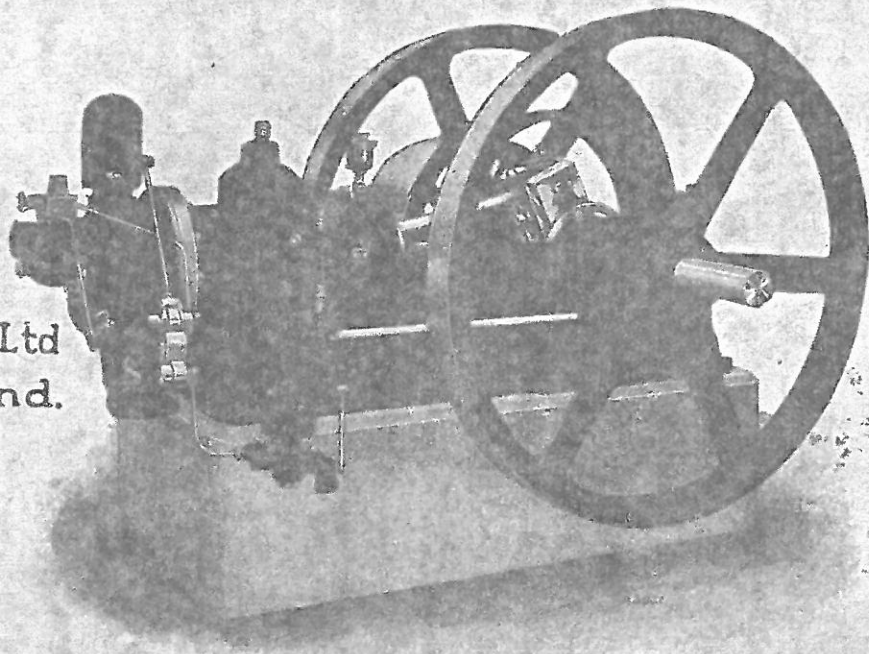

Ruston & Hornsby Ltd  
Lincoln — England.

# OIL ENGINES CLASS M

Catalogue 5361 (Reprint).

## Ruston & Hornsby Ltd.

*Engineers*                      **Lincoln**                      *England*

Works at Lincoln and Grantham comprise 180 acres.

LONDON OFFICE :

**IMPERIAL HOUSE, 15-17-19 KINGSWAY, W.C.2**

MANCHESTER	1 PARSONAGE CHAMBERS, THE PARSONAGE	MELBOURNE	BOURKE STREET
BIRMINGHAM	CHAMBER OF COMMERCE BUILDINGS	SYDNEY	JONES STREET
GLASGOW	200 ST. VINCENT STREET, C2.	BRISBANE	ANN STREET
DUBLIN	190 PEARSE STREET, C5.		

*Telegraphic Address :*  
**Ruston, Lincoln.**

*Telephone :*  
**580 Lincoln (5 lines).**

CODES :

A1. A.B.C. (4TH & 5TH EDITIONS), LIEBER'S, WESTERN UNION, MARCONI'S, ENGINEERING, BENTLEY'S AND PRIVATE CODE



One of the Mansions for which Electric Light is supplied by a Class M Engine.

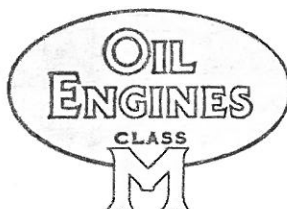

THE  
CLASS "M" OIL ENGINE

is the outcome of a long series of experiments and tests carried out by our highly experienced Technical Staff.

It forms an intermediate type between the world renowned Hornsby Oil Engine and the Ruston "Cold Starting" types, approaching the simplicity of the one and the economy of the other.

SIMPLE IN CONSTRUCTION  
CLEAN AND EFFICIENT  
SAFE & RELIABLE  
EASY TO START

*"There's a Century's Experience behind a Ruston-Hornsby Engine."*

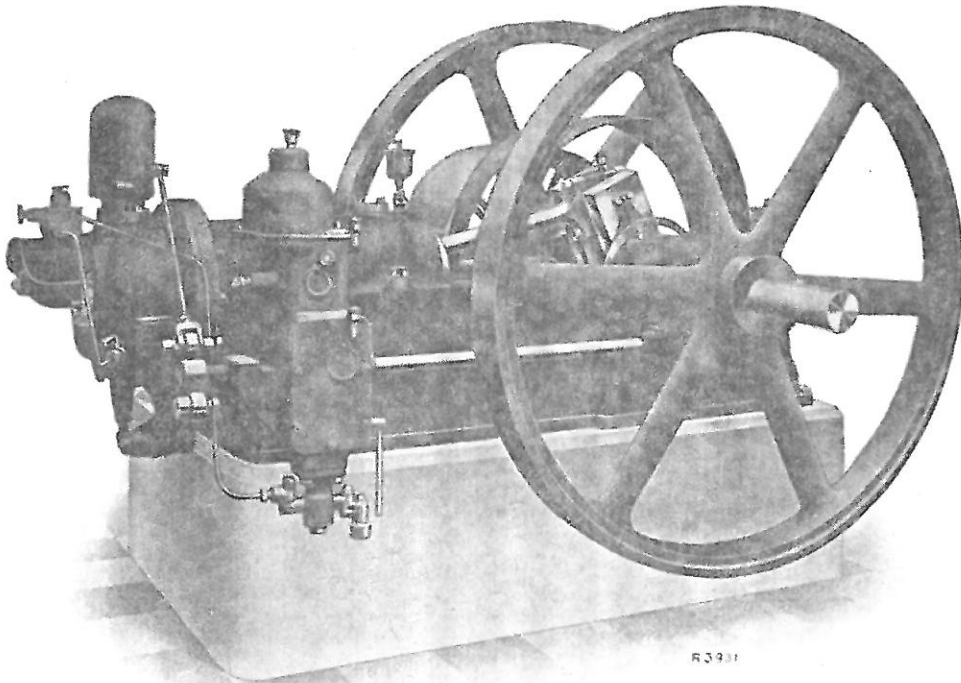

The illustration above shows the Class M Engine as supplied for industrial purposes or for driving a dynamo by belt for charging accumulators.

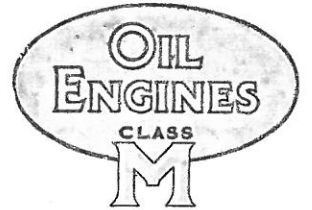

The Class M is a four-stroke engine of simple construction, easily adjusted to its work, and capable of running without constant or frequent supervision. For powers up to 40 B.H.P. it represents the latest development in medium compression oil engines, working without water injection.

### Low Fuel Consumption.

The moderate compression suffices to give efficient combustion, which ensures a low consumption. With average fuel oils consumptions of .48 and .6 lb. per B.H.P. per hour are obtained according to the size of the Engine.

### Cleanliness and Efficiency.

It is a clean Engine to work. The oil is injected by a powerful pump which is quiet in working. The jet of oil enters the vaporiser under sufficiently high pressure to ensure thorough atomisation and absence of carbon deposits in the working cylinder. Its cleanliness in working ensures minimum wear and tear.

### Safety and Reliability.

It is a safe and reliable Engine. The working pressures are low and the build substantial, whilst simplicity has been the key-note in design.

---

---

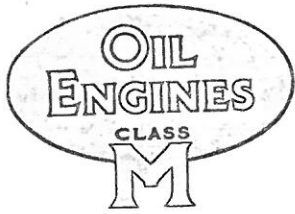

## Ease in Starting.

The Engine is easy to start. The vaporiser is small and takes only a short time to heat before starting. The few minutes taken to heat the vaporiser is not lost time, but may be utilised to fill up the lubricators and look over the engine to make sure that all is ready before starting. It can be readily started

by hand or where conditions obtain that the engine has to start on load, a compressed air starter can be supplied. A petrol starting attachment as illustrated on page 16 can be fitted at an extra charge.

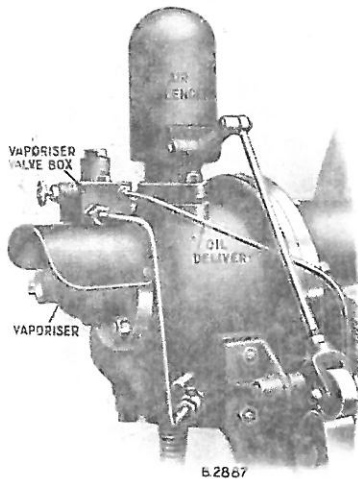

## Air Intake.

To provide against dust entering with the air a filter is fitted over the air inlet valve; this also acts as a silencer for the air suction.

## Durability.

The durability of the engine is equal to that of its fore-runners, and is secured by the use of suitable high-grade material and high-class workmanship.

## Economy.

The economy of the engine lies in its durability and low fuel consumption, and also in the absence of complicated parts, which render it safe in the hands of a man of average intelligence, special training not being essential.

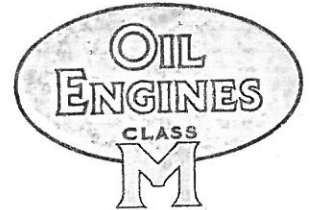

## Governing.

Close governing is attained by means of a highly sensitive governor controlling the stroke of the fuel pump, which regulates the supply of oil fuel according to the load upon the engine.

The Governor is of the high speed spring-loaded type driven by machine-cut gear wheels from the cam-shaft.

An adjustment is fitted enabling the speed of the engine to be varied somewhat. The pump and governor gear is totally enclosed, provided with inspection doors and adequate lubricators.

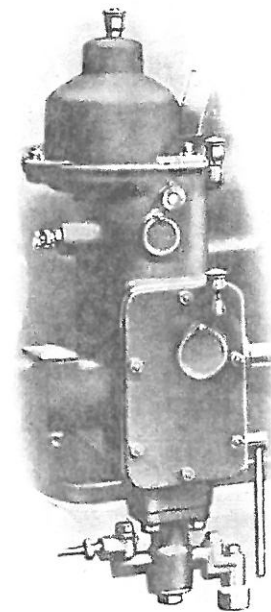

## Fuel Oils.

The Class "M" Engines will run efficiently, without alteration, on a wide range of fuel up to and including Standard Diesel Engine Oil.

## Testing.

Each engine is tested by an expert before being sent out. It is run for a sufficiently long period to make sure of the perfect adjustment of all its parts, and to prove its power. Records of the testings are preserved, and a copy can be supplied if desired.

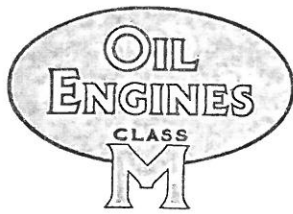

## Lubrication.

The lubrication, which is the chief factor in constant and efficient working, has received careful attention. Every

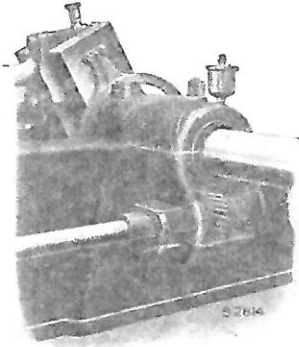

wearing part can be lubricated without difficulty. Sight feed lubricators supply oil to the gudgeon pin, the piston, the piston rings and the connecting rod. Rings working in an oil bath provide lubrication for the crankshaft bearings, and also for the side shaft bearings on the larger sizes. Centrifugal oilers fed from a sight lubricator are used for the crank pin.

All oil holes are in sight.

## Oil for Lubrication.

It is most important that only the best and most suitable oils should be used. It is false economy to use cheap oils for

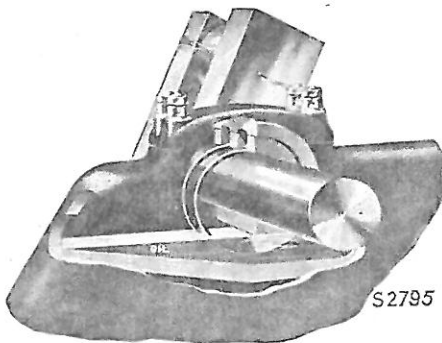

so important a purpose as lubrication, upon which the very life of the engine depends. The oil used should have high flash and evaporating points, and possess high lubricating properties with freedom from carbon deposits under working temperatures.

We supply special selected oil for this purpose.



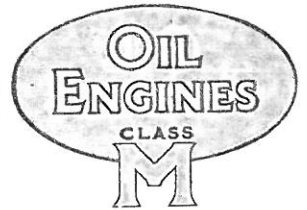

## Other Points.

The main bearings are of ample size and are so designed that they can be removed with the least amount of labour, and without taking out the crankshaft.

The piston is machine ground to obtain great accuracy and prevent wear. The piston pins are case-hardened and ground.

The cylinder is water cooled for practically its entire length.

The cylinder jackets are fitted with hand holes for cleaning out any sediment deposited by the cooling water.

Oil throwers are on the crankshaft to prevent oil creeping along the shaft to the flywheel, pulley, or belts.

The weights on the crank-cheeks accurately balance the crank and other moving parts.

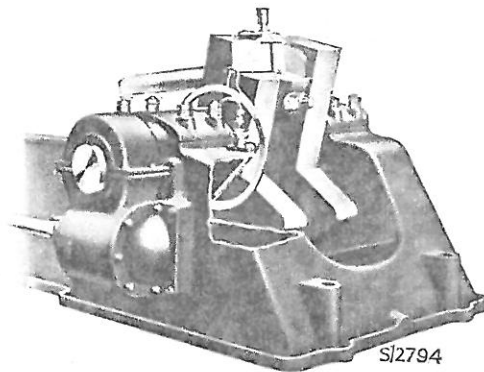

A compressed oil-vapour lamp is provided for heating up the vaporiser when starting ; no lamp is required when the engine is running.

An oil tank of mild steel is supplied with oil filter.

In all engines the top of the flywheel runs away from the cylinder.

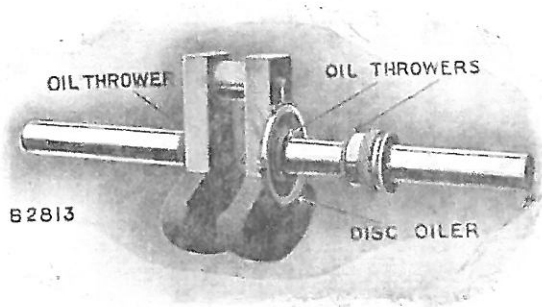

Crankshaft with Balance Weights, Disc Oilers and Oil Throwers

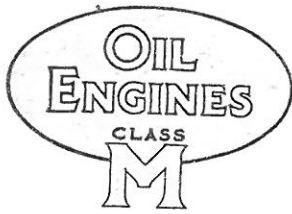

The Class M Engines are suitable for Ordinary  
Factory Driving or for Driving a Dynamo by Belt  
for Charging Accumulators.

For Specification see page 14.

Mark	B.H.P.		Revs. per Minute	Size of Flywheels		Size of Standard Pulley		Width of Leather Belt	Mark
	Fuel Oil	Refined Oil		Diam	Width	Diam	Width		
2 M	6½	7½	350	Ft. 3	In. 3 × In. 3½	In. 18	In. 8	3½	2 M
3 M	10	11	320	3 9	× 4	20	× 10	Single	3 M
3 XM	12½	13½	310	4 0	× 4	20	× 10		3 XM
4 M	15	16½	300	4 6	× 4½	22	× 11		4 M
5 M	20	22	280	4 9	× 5	26	× 12	Light Double	5 M
6 M	25	27½	270	5 0	× 5	30	× 13		6 M
7 M	30	33	260	5 3	× 6	36	× 14		7 M
8 M	36	40	250	5 9	× 6	42	× 15		8 M

Each Engine before leaving our Works is tested to our full satisfaction on the loads given in column 2 for such time as is necessary to ensure that it can carry the same continuously for 12 hours, and this load must not be exceeded for the daily working load of the Engine in order that the best fuel economy shall be realized and that there shall be a margin to meet temporary overloads. A further margin in power may be necessary when an engine is required to run day and night continuously. Each engine is further tested for one hour at a load 10% in excess of the B.H.P. given in column 2.

The "Fuel Oil" powers quoted are obtained with fuel of not less than 18,000 B.Th.U.'s gross per lb. and specific gravity not exceeding .9.

The "Refined Oil" powers are obtained with standard grades of paraffin.

An allowance must be made also in the power margin as follows:—

When the temperature of the air supply rises above 95°F. a reduction of 1% must be made in the working load of the engine for each rise of 5°F.

For each 1000 ft. altitude above 330 ft. above sea level a reduction of 3% must be made.

Mark	Standard Water Vessels						Bore of Water Circul- ating Pipe	Bore of Exhaust Pipes		Smallest Size of Engine Room recommended when Water Vessels are outside		Approximate Weight	
	Temperate Climates			Hot Climates				to Silencer	to Atmo- sphere			Packed	Un- packed
	No.	Diam.	Height	No.	Diam.	Height							
2 M	1	Ft. 2 6 In. 5 0	1	Ft. 3 0 In. 7 6	1	Ft. 3 0 In. 7 6	In. 1	In. 2½	Ft. 9 0 In. x 7 6	Cwt. 21	Cwt. 17		
3 M	1	2 9 7 6	1	3 9 8 0	1	3 9 8 0	1½	2	10 6 x 8 0	29	24		
3XM	1	3 0 7 6	1	3 0 8 0	1	3 0 8 0	1½	2½	11 0 x 8 3	35	30		
4 M	1	3 3 8 0	1	3 3 8 0	1	3 3 8 0	1½	2½	11 6 x 8 6	41	35		
5 M	1	3 9 8 0	1	3 8 8 0	1	3 8 8 0	2	3	12 0 x 9 0	47	40		
6 M	1	3 0 7 6	1	3 3 8 0	1	3 3 8 0	2	3	12 6 x 9 6	57	48		
	1	3 3 7 6	1	3 6 8 0	1	3 6 8 0							
7 M	1	3 3 8 0	1	3 8 8 0	1	3 8 8 0	2½	3½	13 6 x 10 0	71	60		
	1	3 6 8 0	1	4 0 8 0	1	4 0 8 0							
8 M	1	3 6 8 0	1	3 3 8 0	1	3 3 8 0	2½	4	14 6 x 10 9	84	72		
	1	3 9 8 0	1	3 6 8 0	1	3 6 8 0							

4M Engines and upwards can be fitted with Compressed Air Starting Valves if required.

Compressed Air Starter is recommended for the 8 M.

All Engines with exception of Mark 2M may be fitted, at an extra charge, with  
the Petrol Starting Attachment described on page 16.

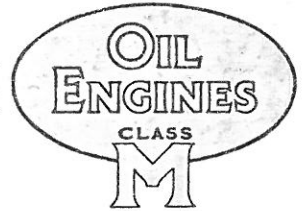

The Class ME Engines (as illustrated below) are suitable for Direct Coupling to Dynamos

For Specification see page 14.

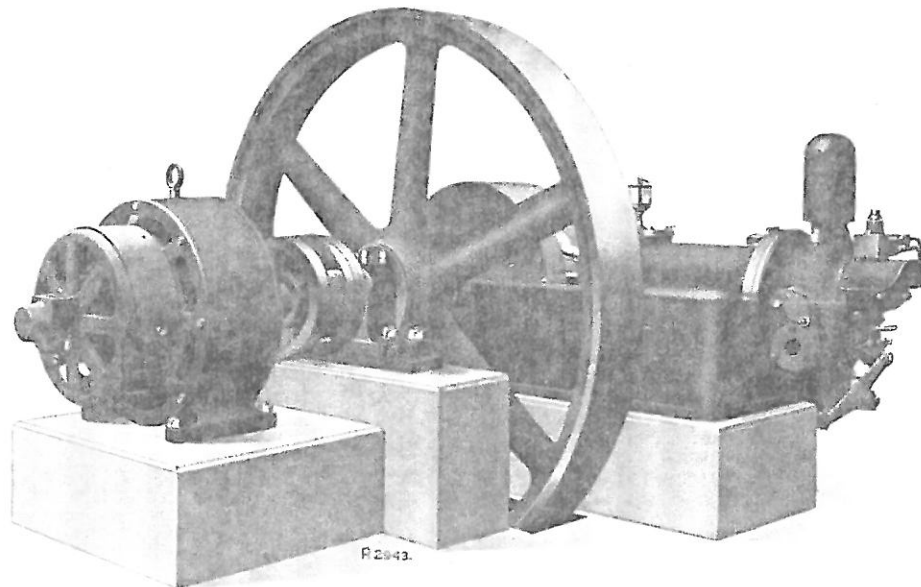

Mark	B.H.P.		Revs. per Minute	Size of Flywheel		Standard Dynamo Driving Pulley		Width of Leather Belt	Approximate Weight		Mark	
	Fuel Oil	Refined Oil		Diam.	Width	Diam.	Width		Packed	Un-packed		
2 M E	6½	7½	350	Ft. 4	In. 9 x 5	In. 24	In. 4	3	Single	Cwt. 22	Cwt. 18½	2 M E
3 M E	10	11	320	5	6 x 7	30	x 4			32	29	3 M E
3 X M E	12½	13½	310	6	0 x 7	33	x 4½	4	Light Double	40	36	3 X M E
4 M E	15	16½	300	6	0 x 9	36	x 5			48	43	4 M E
5 M E	20	22	280	6	3 x 9	39	x 5	5	Light Double	58	51	5 M E
6 M E	25	27½	270	6	11 x 9	42	x 6			77	69	6 M E
7 M E	30	33	260	7	1 x 9	48	x 6	6	Light Double	91	83	7 M E
8 M E	36	40	250	7	6 x 11	50	x 7			112	100	8 M E

The dimension of Water Vessels, Water and Exhaust Pipes are as given in opposite table.

Compressed Air Starter is recommended for 6, 7 and 8 M E.

See also the notes on Power as appearing on page 10.

Fig. 1.  
Class M Engines  
with  
Two Flywheels.

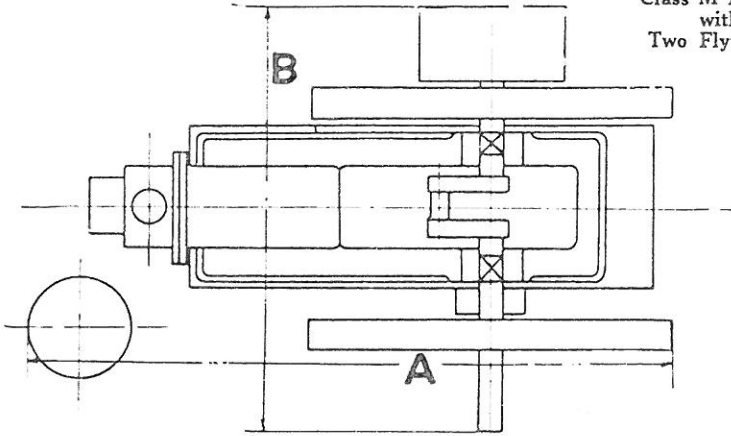

Fig. 2.  
Class ME Engines  
for  
Direct Coupling  
to Dynamo.

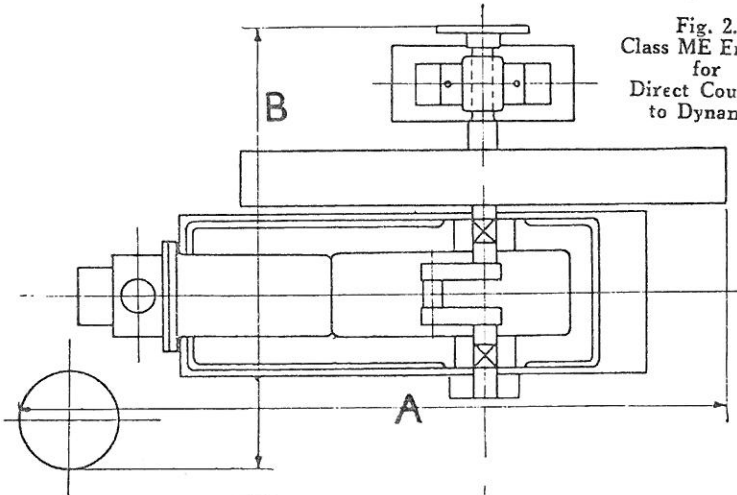
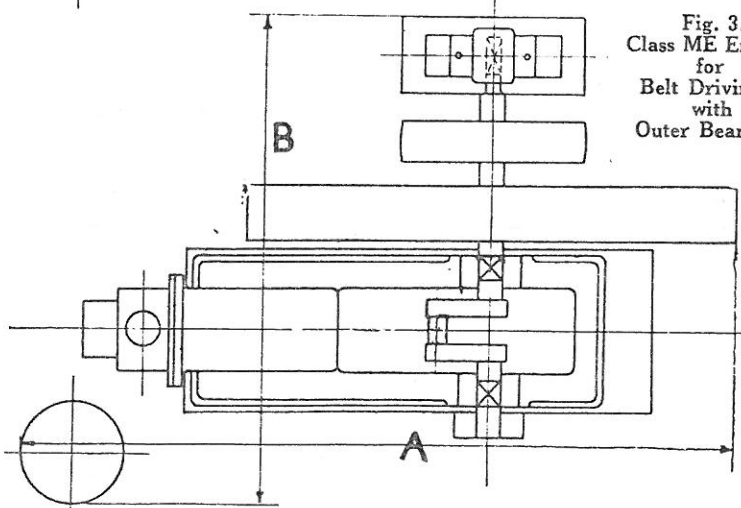
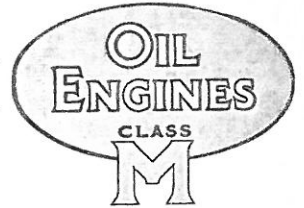

Fig. 3.  
Class ME Engines  
for  
Belt Driving  
with  
Outer Bearings.





## APPROXIMATE DIMENSIONS

Class M.

Class ME.

*For Specification see page 14.*

Mark	A	B	Height to top of Flywheel	Mark	A	B		Height to top of Flywheel
						Direct Coupled Fig. 2	Pulley Drive Fig. 3	
2 M	Ft. In. 6 0	Ft. In. 4 0	Ft. In. 3 11	2 M E	Ft. In. 6 9	Ft. In. 4 9	Ft. In. 5 0	Ft. In. 4 8
3 M	6 10	4 7	4 3	3 M E	7 9	5 1	5 6	5 2
3 XM	7 4	4 8	4 6	3 XME	8 4	5 4	5 9	5 6
4 M	7 10	5 3	4 11	4 M E	8 7	5 6	5 10	5 8
5 M	8 6	5 8	5 2	5 M E	9 3	5 10	6 3	5 11
6 M	9 0	6 1	5 5	6 M E	10 0	6 3	6 9	6 4
7 M	9 6	6 7	5 8	7 M E	10 6	6 5	7 2	6 6
8 M	10 6	7 2	5 11	8 M E	11 3	7 3	8 0	6 11

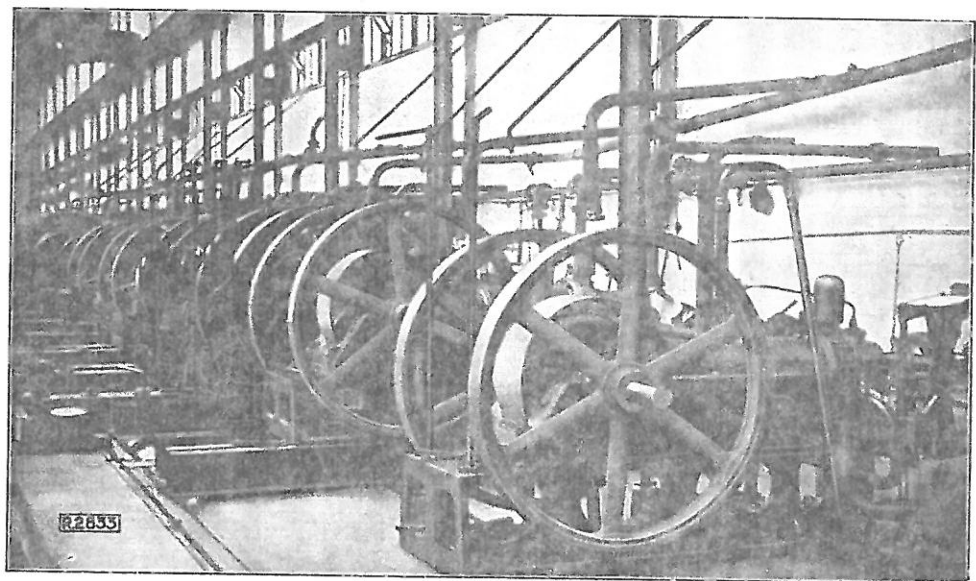

Portion of Testing Bay at Grantham showing row of  
Class M Oil Engines being tested before delivery.

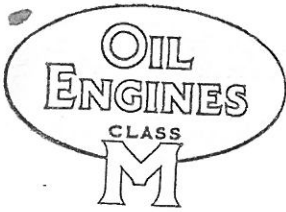

## GENERAL SPECIFICATION

These engines are designed for mounting on concrete bases with an independent oil tank.

### CLASS M ENGINES

Are fitted with two flywheels (fig. 1, page 12). The face of flywheels is rounded on the 2M to 5M sizes enabling the drive to be taken from the wheel if desired. The standard position of pulley is on the side opposite to camshaft, but the crankshaft is long enough on the camshaft side to take the pulley if desired.

If a pulley be ordered for a Class M Engine the "standard industrial pulley" will be sent, unless the "standard dynamo driving pulley" is distinctly specified.

### CLASS ME ENGINES

Are suitable for direct coupling to a dynamo (fig. 2, page 12). They are fitted with a single heavy flywheel and outer bearing and soleplate.

The standard position of the flywheel is on the opposite side to camshaft. The outer bearing is brought close up to the flywheel and the crankshaft extended through the bearing to take a flexible coupling.

The dynamo should be of the two bearing type and a flexible coupling must be used.

There is no provision for a pulley.

Class ME Engines can be specially supplied for belt driving if required (fig. 3, page 12). The outer bearing is placed at the end of the crankshaft, leaving space for a "standard industrial pulley" between the flywheel and the outer bearing.

If a pulley be ordered for a Class ME Belt Drive, the "standard dynamo driving pulley" will be sent, unless the "standard industrial pulley" is distinctly specified.

### SPARES AND TOOLS

The following are supplied :—Set of Piston Rings, set of Springs, set of Spanners and a Special Tool for grinding in Valves, Oil Can and Bottle.

### NOTE.

Any alteration from our standard specification may involve increase in price and delay in delivery.

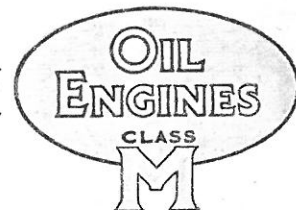

### SELECTING AN ENGINE.

In selecting a suitable type and size of engine there are several points to which due consideration should be given. The most important of these are :—

1. The class of oil it is proposed to use.
2. The duty the engine will be called upon to perform.
3. The period it is required to run without stopping.
4. The altitude at which the engine will work.
5. The atmospheric temperature.

#### 1. CLASS OF OIL.

The Class M Engine will run equally well on refined or crude oils up to and including Standard Diesel Engine Fuel Oil.

#### 2 DUTY OF ENGINE.

There is considerable variety in the kind of work an engine is called upon to perform. In one case the load to which the engine is subjected may be steady and regular, in another intermittent and fluctuating, and in another there may be unexpected "peak-loads." It is therefore very important that the nature of the load should be stated, also the MAXIMUM load the engine is likely to carry.

#### 3. PERIOD OF WORK.

Further, it is desirable that intending purchasers should state the longest period the engine is likely to have to run without a stop. These engines are particularly suitable for long and continuous runs.

When intending purchasers are uncertain as to the power required, Messrs. R. & H. are always pleased to advise on receipt of particulars as to the number, class and duty of the machines it is proposed to drive, and also the period of the run.

#### 4. WORKING AT AN ALTITUDE.

When engines are required to work at an altitude, an allowance must be made for the loss in power ; this can be taken as 3% for every 1000 feet above 330 feet above sea level, due to diminished atmospheric pressure.

#### 5. ATMOSPHERIC TEMPERATURE.

An allowance must be made also in the power margin when the temperature of the air supply rises above 95°F. A reduction of 1% must be made in the working load of the engine for each rise of 5°F.

#### GUARANTEE.

In lieu of any warranty implied by law, we expressly guarantee to repair or supply new any part which within a period not exceeding twelve months from delivery, may prove defective through bad material or workmanship ; but all goods are supplied on the condition that we shall not be liable for any losses incurred through stoppages, nor for any direct or consequential damages.

## Petrol Starting Attachment.

*Enables Engines to be started from cold without the use of a Blow Lamp.*

The attachment consists of a simple carburetter, with Sparking Plug and the necessary connections for bolting on to the Cap End, and a High Tension Magneto with Bracket, Cam and Cut-out Gear.

The quantity of Petrol required for starting is very small, being about an egg cup full at each start. The engine is set in motion by pulling round the fly-wheel. Engines sizes 4 M and above can be arranged, at an extra charge, with Compressed Air Receiver and Starting Valve in addition to the Petrol Starting Attachment. After the Engine has run a few revolutions upon the Petrol, the petrol supply is cut off, and the fuel pump put into gear.

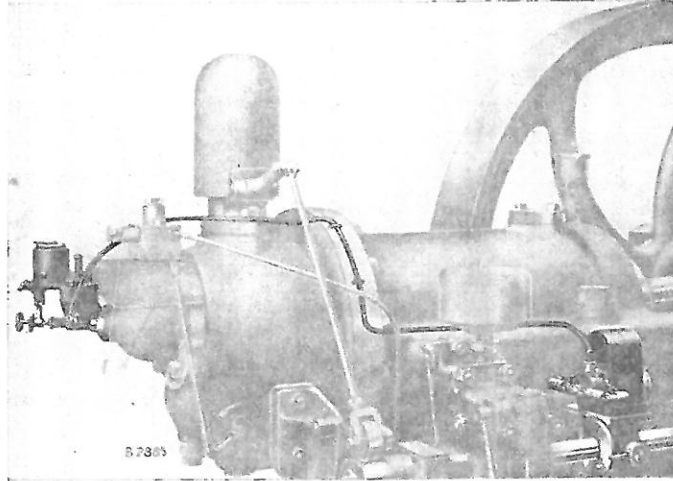

After the Engine has run a few revolutions upon the Petrol, the petrol supply is cut off, and the fuel pump put into gear.

The Carburettor is shut off from the Cap End by a valve, so that the sparking plug is kept clean and is protected from the combustion of the main fuel.

The Magneto is driven by a Cam on the sideshaft which can be slid out of gear as soon as the Engine is running upon fuel oil.

■ ■ ■ ■

*The firm of Ruston & Hornsby Ltd. is the amalgamation of two old-established Engineering firms:*

**RUSTON, PROCTOR & Co., Ltd. (Est. 1840), LINCOLN, and  
RICHARD HORNSBY & SONS Ltd. (Est. 1815) GRANTHAM.**

*Both firms have had long experience in the manufacture of Steam, Gas and Oil Engines and have made over 120,000 Engines.*

While every care is taken in the preparation of this Catalogue—which cancels all previous editions—the illustrations, specifications and dimensions must not be taken as binding until confirmed by us, alterations being necessary from time to time. Any variations from our standard specification may involve increase in price and delay in delivery.